



WS07512L

Quadris 12W LED

Decorative Metal Wet Location Wall Sconce

Catalog No. _____

Type _____

Project _____

Specifications/Features

Housing

LED Wall sconce blends the perfect size and illumination for hallways, reception areas or individual rooms and offices.

Metal faceplate over an acrylic diffuser provides a soft, luminous glow while illuminating the surrounding wall. Ideal for low glare applications.

Select from seven different faceplate designs in Antique Bronze, Black, Silver or White finishes. Optional colored diffuser sold separately, standard color is white.

Custom faceplate designs and diffuser colors available; consult factory.
 ADA compliant for use throughout your building space; sconce measures 9-3/8" x 10-1/4" H x 3-7/8" D.

Lamp

(3) LEDs, 350mA Constant Current; 12W Total.

Color Temperature: 2800K

Electrical

Driver: 120V primary, 350mA secondary. 60Hz.

Input Current: 0.4A max.

Mounting

Hardware included for mounting of fixtures to octagonal or rectangular switch junction box.

Warranty

This complete fixture is covered by Con-Tech's full five (5) year replacement guarantee after date of purchase.

Listing

CSA listed. Suitable for wet locations (IP44).

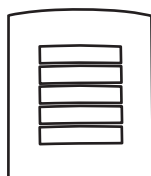
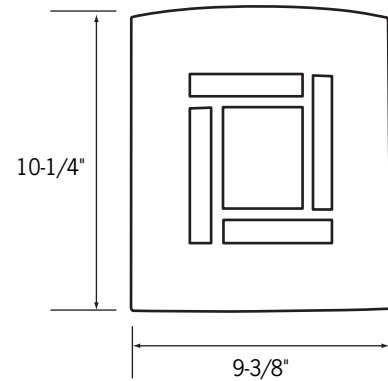

1 - Horizontal

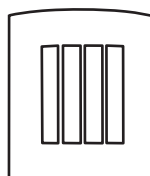

2 - Vertical

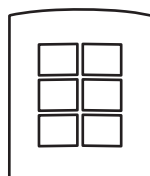

3 - Squares

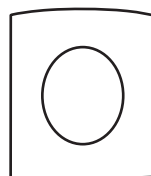

4 - Oval

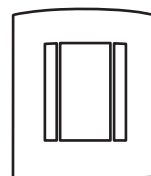

5 - Trio

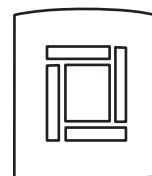

6 - Mosaic

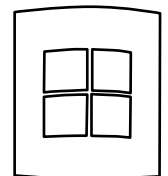

7 - Window

Ordering Information

Example Order:

Fixture	Driver	Faceplate Design	Finish
<input type="text"/>	<input type="text"/>	<input type="text"/>	<input type="text"/>

WS07512L

N - Normal Power Factor
H - High Power Factor
D - Dimming

1 - Horizontal
2 - Vertical
3 - Squares
4 - Oval
5 - Trio
6 - Mosaic
7 - Window

AB - Antique Bronze
B - Black
S - Silver
W - White

Optional Colored Acrylic Diffusers



WS075A - Amber
WS075B - Blue
WS075G - Green
WS075R - Red
WS075Y - Yellow