

INSTALLATION PROCEDURES

Identifying Single-Circuit and Two-Circuit Track

- Check the identification label inside the track. Single-circuit track will be labeled with one of the following part numbers: LT-2, LT-4, LT-6, LT-8 or LT-12. Two-circuit track will be labeled with one of the following part numbers: LT-22, LT-24, LT-26, LT-28 or LT-212.
- If you are unable to see the label, measure the height of the track from top to bottom. Single-circuit track will measure 11/16"; two-circuit track will measure 13/16".
- The track can also be identified by looking inside the channel. Single-circuit track will have two conductors, one on each side of the channel. Two-circuit track will have three conductors, two on top of each other on side of the channel, and one on the opposite side.
- To secure track to ceiling, 2', 4', and 6' track sections are supplied with (2) toggle bolts, 8' and 12' track sections are supplied with (3) toggle bolts. If suspending track from the ceiling, (2) supports are recommended per 2', 4', and 6' track section, (3) supports per 8' and 12' track section.

Single- and Two-Circuit Track Proper Polarity Alignment

- Track polarity is indicated by a grooved polarity line that runs the entire length of the track. (Figure 1)
- Track must be joined together maintaining polarity of the entire run. When installing a continuous run of track, do not remove end caps until after the power feed or track connector is inserted in opposite end of track. Place track with end caps against a firm surface, maintaining pressure to keep end cap and internal conductor in place while inserting end feeds or connectors. Failure to follow this procedure may result in loss of electrical connection and arcing.
- To wire track connector, use 12 AWG solid copper wire for 20A circuits only.
 - Fasten positive/hot (black) wire to the positive (brass) screw terminal marked P.
 - For two circuit, fasten one positive wire to screw terminal marked P1 and fasten second positive wire to screw terminal marked P2.
 - Fasten neutral (white) wire to the screw terminal marked N.
 - Fasten ground wire to the green ground screw terminal.
 - Replace track connector cover and secure with screw.
- When installing track end feeds and couplings, the small arrow on the feed or coupling must be inserted into the track pointing at the polarity line. (Figure 2)
- Insert couplings and track feeds fully into track housing maintaining polarity. Tighten set screw at each coupling/feed point.

Single- and Two-Circuit Track Cutting Instructions

If track is cut in the field, the following steps must be completed in order for the track to function properly:

- Aluminum track and plastic insulator must be the same length.
- After cutting track to proper length, all copper conductors must be cut back 3/8" from each end to prevent arcing and allow couplings and power feeds to be inserted completely. (Figure 3)
- Follow all other instructions for installing track once the cuts have been completed. Make sure to continue to follow polarity.

Continued on Page 2

Single-Circuit Track:

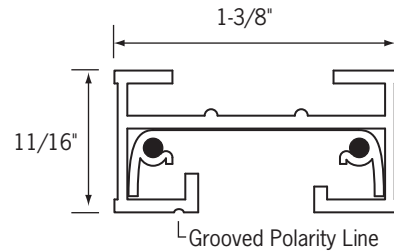

Two-Circuit Track:

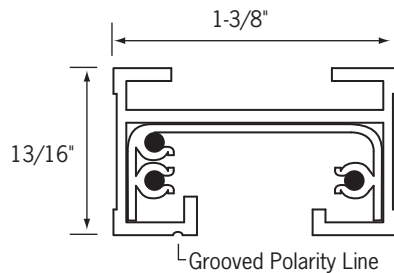

1

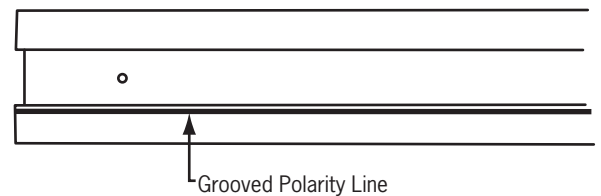

2

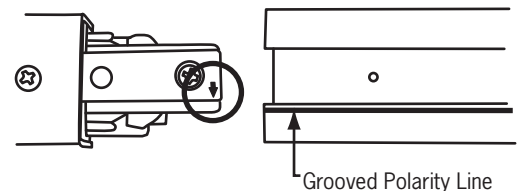

3

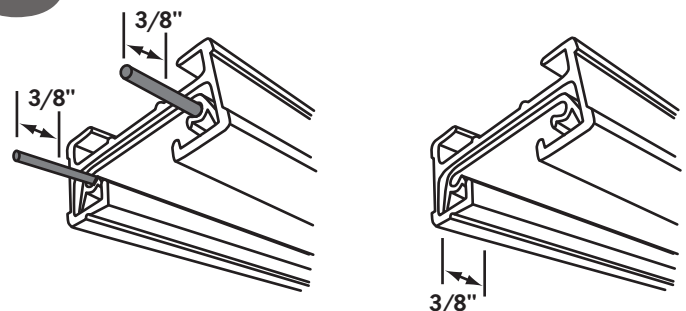

INSTALLATION PROCEDURES

Single-Circuit Fixture Polarity Alignment

- Track polarity is indicated by a grooved polarity line that runs the entire length of the track. Fixtures must be installed so that the arrow on the fixture tab points to the polarity line when it is rotated into place.
- All fixtures have indicator arrows designed to point to the track polarity line.
- To install (Figure 4):
 - A. Insert the fixture contacts into the track channel.
 - B. Retract the track latch by gently pulling down.
 - C. Rotate the adapter 90° so that the polarity arrow points to the polarity line on the track.
- When the fixture is installed, the track latch will lock the fixture into the track. NOTE: All latches should face the same direction after installation.
- Once the fixture is installed into the track, move the ON/OFF switch to the ON position.

Two-Circuit Fixture Polarity Alignment

All ConTech track fixtures have two contacts in the base that engage conductors within the track; one for neutral and the other for the positive (hot) conductor. Dual circuit tracks contain one neutral and two positive conductors.

- To engage the second live conductor (Figure 5):
 - A. Identify the "POSITIVE" contact on the lighting fixture base, marked "P".
 - B. To access the second circuit, pull up the contact marked "P" to the position shown.
 - C. Slide the plastic shim (shipped with track) beneath the contact, locking the tabs in place.
- Follow fixture installation instructions for Single-Circuit Fixtures.

MAINTENANCE PROCEDURES

- All track fixtures are installed correctly per instructions.
- All fittings, power feeds and connectors are secure and installed properly.
- Be sure all parts (fixtures, track and accessories) are clean and dust free.
- Inspect all lamps, replace burned out lamps, and insure proper type and wattages are being used per UL lamping instructions. When using LED replacement lamps, only use the incandescent equivalent in LED. For example 75W PAR should only be a 10-15W LED, don't overlamp.

IMPORTANT SAFETY INSTRUCTIONS:

- Read all the instructions before installation. Save instructions for later use.
- Turn off power at fuse or circuit breaker box before installation or before doing any maintenance work.
- Wear rubber soled shoes should and work on a sturdy wooden or non-conductive ladder.
- Product must be mounted in locations and at heights in a manner consistent with its intended use, and in compliance with National Electrical Code and local building codes. For indoor use only.
- Do not exceed the nominal supply voltage or amperage ratings.
- Do not install any lampholder closer than 6" from any curtain or similar combustible material.
- Installing contrary to instructions may cause unsafe conditions.
- **Warning:** Risk of fire. Most dwellings built before 1985 have supply wire rated at 60°C. Consult a qualified electrician before installation.
- **CAUTION:** To reduce the risk of fire and electrical shock, use only fixtures and fittings intended for use with the ConTech single circuit or 2-circuit, 120V systems.
- The track and all components are rated for 120V, 20A capacity. (2400W max at 120V)
- Do not exceed the nominal supply voltage or amperage rating.
- To avoid hazards to children, account for all parts and properly dispose of all packing materials.
- Call the Technical Support department at ConTech Lighting with any installation questions: 847.559.5500.

4

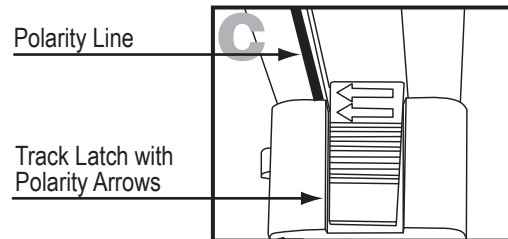
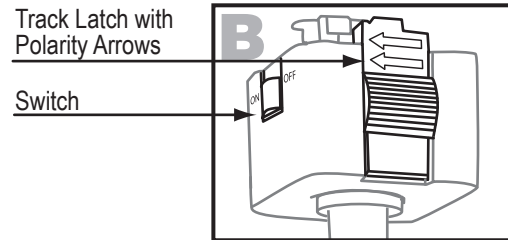
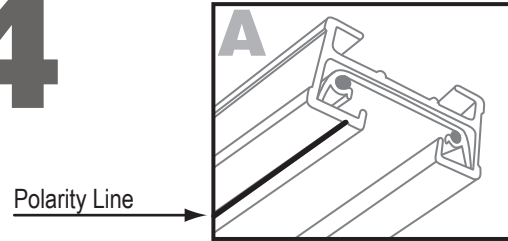

5

