

RL16G-ICSA

4" 120V/20W GU10 Downlight

New Construction, Insulated Ceiling, StopAire® Housing

Specifications/Features

Housing/Mounting

New Construction housing for use in hard and grid type ceilings. For use in applications with direct contact with insulation materials. White painted steel lamp housing and galvanized steel mounting frame. Lamp housing is removable through ceiling aperture to access junction box. Housing adjusts to various ceiling thicknesses with three (3) screws. Dual extension hanger bars span from 15" to 25-1/4" with reversible placement feature. Hanger bars may be extended to rest on T-bar grid

Megaman® Lamp (Optional)

Energy efficient, 6W or 7W PAR16 LED lamp
 Designed to last 25,000 hours
 Correlated Color Temperature of 2700K, 3000K, or 3500K, with Color Rendering Index of 82

Correlated Color Temperature of 4000K, Color Rendering Index of 85

6W PAR16 Lamp

Lumen output = 550 (92 Lumens per Watt)

24° Beam spread with CBCP of 2100

35° Beam spread with CBCP of 1240

7W PAR16 Lamp

Lumen output = 530 (75.7 Lumens per Watt)

35° Beam spread with Max. Luminous Intensity (cd) of 600

Durable die-cast aluminum housing with lens to protect the LEDs and reflector
 RoHS compliant, contains no lead or mercury

Dimming (MEGAMAN® Lamps)

Dimmable to 10% with forward phase/TRIAC dimming.

For optimal performance, use forward phase/TRIAC dimmer specifically designed for LED lamps.

Dimming performance may vary due to field conditions, including but not limited to, power quality, installation and wiring, and variations in dimmer production. Please reference the dimmer manufacturer's instructions for dimmer installation and further information.

For other manufacturer LED lamp compatibility, please consult factory.

Electrical

(1) 20W Max., 120V PAR16, GU10 base or MR16, GU10 base.

Porcelain socket.

J-box has (4) 1/2" pryouts, (2) 1/2"x 3/4" concentric pryouts, and (4) sheathed cable pryouts. Spring latch access covers. Approved for through branch circuit wiring. Max.: (8) 12AWG (4 in/4out), Min. 75°C permitted.

Trims

Baffle, multiplier, adjustable, and decorative trim options available to suit a broad range of applications. See 4" Trims section of specification sheet for details

Warranty

This fixture is covered by ConTech's full one (1) year replacement guarantee after date of purchase. When used with Megaman® lamp option, a (3) year replacement guarantee after date of purchase is provided.

Labels/Usage

cCSAus Certified to UL Standards. Suitable for damp locations.

Lamp is Energy Star Listed.

Conforms to Washington State Energy Code (WSEC) for low air infiltration.

Tested in accordance with ASTM E283 (2.0 CFM or less).



6W PAR16, 24°



6W PAR16, 35°



7W PAR16, 35°

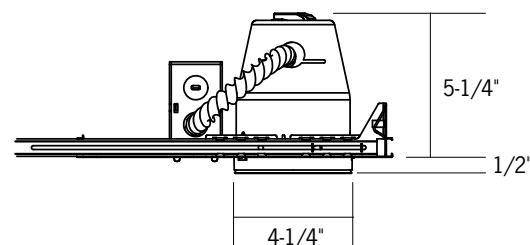
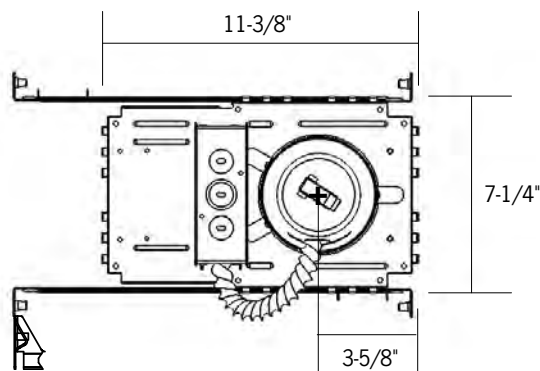

Ceiling Opening: 4-3/8"

Ceiling Thickness: 1/2" – 1-1/2"

RL16G-ICSA

4" 120V/20W GU10 Downlight
New Construction, Insulated Ceiling, StopAire® Housing

Catalog No. _____

Type _____

Project _____

Ordering Information

Example Order: - -

Housing

RL16G-ICSA

Lamp

- LEAVE BLANK** - NO LAMP
- ML06-2427K** - 6W, 24°, 2700K
- ML06-2430K** - 6W, 24°, 3000K
- ML06-2435K** - 6W, 24°, 3500K
- ML06-2440K** - 6W, 24°, 4000K
- ML06-3527K** - 6W, 35°, 2700K
- ML06-3530K** - 6W, 35°, 3000K
- ML06-3535K** - 6W, 35°, 3500K
- ML06-3540K** - 6W, 35°, 4000K
- ML05-3527K** - 7W, 35°, 2700K
- ML05-3530K** - 7W, 35°, 3000K
- ML05-3540K** - 7W, 35°, 4000K

Options

- CP** - Chicago Plenum
- HB-30** - T-Bar Hanger Set

Trims for 4" RL16G Series Housings

- All trims have white trim ring finish unless specified.
- All trims are cCSAus Certified and suitable for damp locations; only shower trims are rated for wet locations.
- All trims compatible with Megaman® PAR16 lamps. For other manufacturer LED lamp compatibility, please consult factory.
- Clear lens provided with trim should only be used with open MR16 lamps. Lens should not be used with LED lamps.

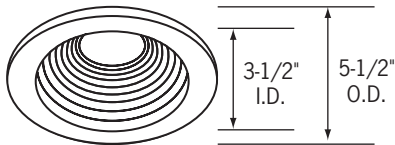

CTR1601-B*
Adjustable Black Baffle, Black Trim Ring

CTR1601-P*
Adjustable Black Baffle

CTR1601-P-WHT*
Adjustable White Baffle

Deep baffle traps stray light and conceals lamp. May be used as downlight or adjustable accent light with 60° swing adjustment.

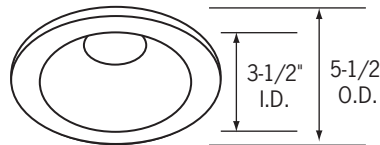

CTR1602-P-(BLK, CLR, PL, WHT)*
White Trim Ring, Select Reflector Finish

CTR1602-B-BLK*
Black Trim Ring, Black Reflector

CTR1602-(ST, NK)-CLR*
Select Metal Trim Finish, Clear Reflector

Multipliers utilizes a highly polished, specular reflector to maximize light intensity while concealing the light source. Offers the flexibility to be used as a downlight or adjustable accent light with 35° swing adjustment.

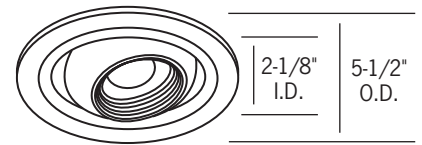

CTR1608-P
Black Baffled Eyeball

Up to 45° vertical aiming, 358° rotational adjustment. Black baffle provides excellent cutoff and lamp concealment. 45mm lens.

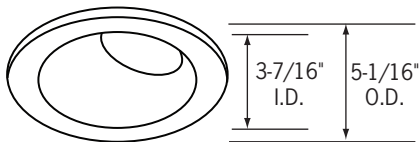

CTR1614-P-CLR
Clear Reflector Angled Wall Wash
Adjustable lampholder; 55-75° aiming angle. 45mm lens.

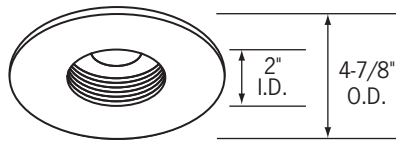

CTR1605-P*
Black Baffled Pin Spot

CTR1605-P-WHT*
White Baffled Pin Spot

Precise beam spread and unobtrusive appearance. Concealed lamp design for maximum eye comfort. Deep baffle.

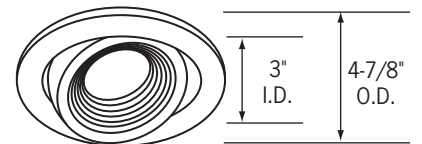

CTR1609-P
Surface Adjustable, Cast Black Baffle

CTR1609-P-WHT
Surface Adjustable, Cast White Baffle

Low glare baffle. Downlight or adjustable accent light with up to 35° vertical and 358° rotational adjustment. 50mm lens.

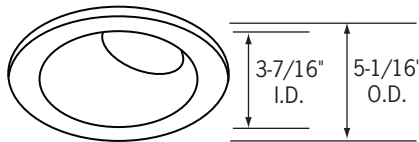

CTR1614CL-P-CLR
Angled Wall Wash Shower Trim
Die cast aluminum. Clear specular angled reflector. Adjustable lampholder; 55-75° aiming angle. Double neoprene gasketed. Clear glass lens. 45mm lens.

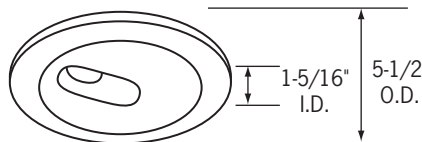

CTR1603-P
Slotted Wall Wash
Slot aperture permits maximum beam area adjustment for either wall wash or concealed accent lighting effects. 50° swing adjustment, 358° rotation. 50mm lens.



CTR1624G- (B, P)
Fully Adjustable Square in Round, Select Finish
87° vertical and 359° rotation adjustment. Die-cast aluminum construction. Front access, spring latch lamp retainer ring. 47mm lens. Depth from ceiling: 2-1/2"

All finishes are not available for all trims.

Reflector Finish Options:

- CLR** - Clear, Specular
- BLK** - Black, Specular
- WHT** - White Light, Specular
- PL** - Platinum, Matte

Trim Finish Options:

- P** - White
- B** - Black
- NK** - Nickel
- ST** - Brushed Stainless Steel

*Trim uses stepped lens holder design and can hold up to two (2) light controlling elements. 45mm lens on lower level of lamp seat, 50mm lens on higher level.

CONTINUED

Trims for 4" RL16G Series Housings

- All trims have white trim ring finish unless specified.
- All trims are cCSAus Certified and suitable for damp locations; only shower trims are rated for wet locations.
- All trims compatible with Megaman® PAR16 lamps. For other manufacturer LED lamp compatibility, please consult factory.
- Clear lens provided with trim should only be used with open MR16 lamps. Lens should not be used with LED lamps.

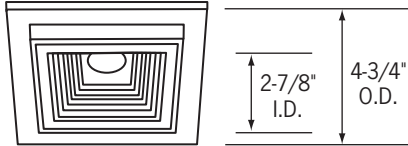

CTR1604-P

Black Baffled Square

Deep baffle traps stray light and conceals light source. Downlight or adjustable: up to 35° vertical adjustment. 45mm lens.



CTR1601SQ-B

Adjustable Black Baffle, Black Trim

CTR1601SQ-P

Adjustable Black Baffle, White Trim

CTR1601SQ-WHT

Adjustable White Baffle, White Trim

Deep baffle traps stray light and conceals lamp. May be used as downlight or adjustable accent light with 60° swing adjustment.

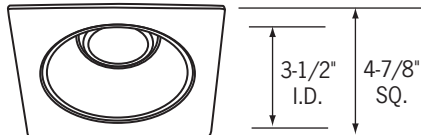

CTR1602SQ-B-(BLK, CLR)

Adjustable Multiplier; Black Trim, Black or Clear Reflector

CTR1602SQ-P-(CLR, WHT)

Adjustable Multiplier; White Trim, Clear or White Reflector

Multipliers utilizes a highly polished, specular reflector to maximize light intensity while concealing the light source. Offers the flexibility to be used as a downlight or adjustable accent light with 35° swing adjustment.

All finishes are not available for all trims.

Reflector Finish Options:

CLR - Clear, Specular
BLK - Black, Specular
WHT - White Light, Specular
PL - Platinum, Matte

Trim Finish Options:

P - White
B - Black
NK - Nickel
ST - Brushed Stainless Steel

*Trim uses stepped lens holder design and can hold up to two (2) light controlling elements. 45mm lens on lower level of lamp seat, 50mm lens on higher level.